

Article number: 53090101

Description: KLEE Hydraulic lubricating nipple DIN 71412
H1 straight, G1/8

Measures

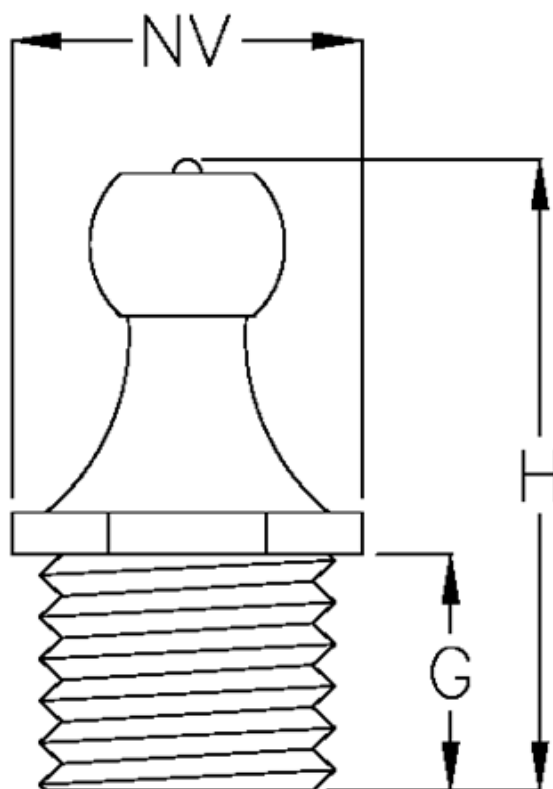

G	= 5,5
H	= 15,3
NV	= 10,9
Thread	= G1/8